

GRUA TORRE / TOWER CRANE

GRUE A TOUR / БАШЕННЫЙ КРАН /

رافعة برجية / KULE VINÇ

J4510



UNE 58-101
FEM 1001

UNE-EN-ISO 9001

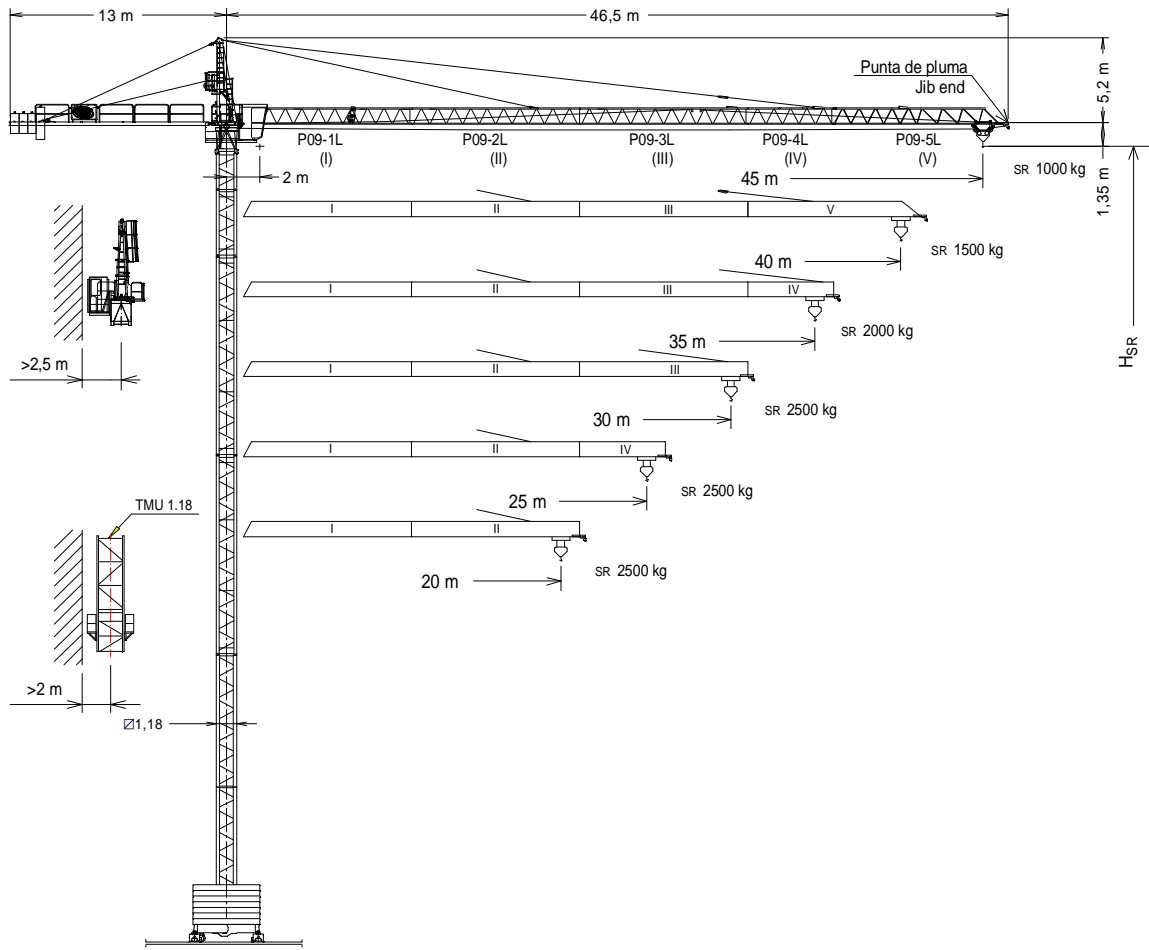





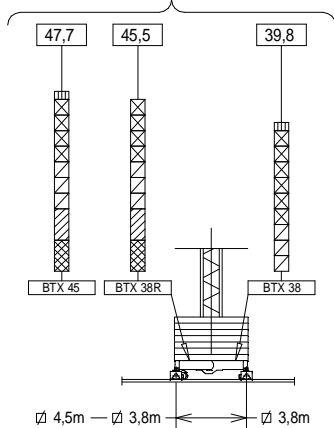

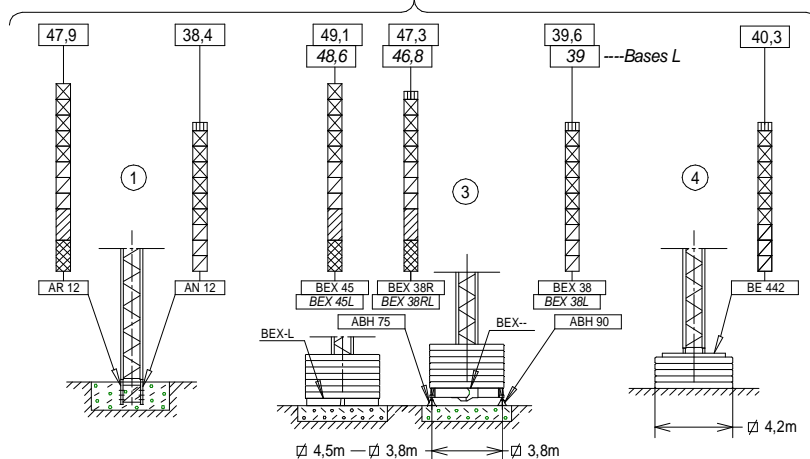

<p>Altura máxima bajo gancho sin arriostrar (m). Maximum height under hook without fastening (m). Hauteur maximale sous crochet sans ancrage (m). Максимальная высота под крюком без крепления (m). Bağlantısız maksimum kanca altı yüksekliği (m). أقصى ارتفاع تحت الخطاف بدون ربط (m)</p> <p>$H_{SR} =$</p> <p> $H_{SR} - 2 m.$</p> <p>* Punta de pluma / Jib end / Pointe de flèche / Конец стрелы / Вот усу / مقدمة الذراع</p>	<table border="0"> <tr><td>TMU 1.18</td><td>-----</td><td>202.35.500</td></tr> <tr><td>P09-1L</td><td>-----</td><td>155.40.000</td></tr> <tr><td>P09-2L</td><td>-----</td><td>155.41.000</td></tr> <tr><td>P09-3L</td><td>-----</td><td>155.42.000</td></tr> <tr><td>P09-4L</td><td>-----</td><td>155.43.000</td></tr> <tr><td>P09-5L</td><td>-----</td><td>155.44.500</td></tr> <tr><td>Punta de pluma / Jib end*</td><td>-----</td><td>155.45.000</td></tr> <tr><td>TR 12</td><td>-----</td><td>146.30.000</td></tr> <tr><td>TN 12</td><td>-----</td><td>146.31.000</td></tr> <tr><td>TR 8RM</td><td>-----</td><td>202.30.000</td></tr> <tr><td>TR 8M</td><td>-----</td><td>146.30.800</td></tr> <tr><td>TR 4</td><td>-----</td><td>800.32.300</td></tr> <tr><td>TN 4</td><td>-----</td><td>146.32.000</td></tr> </table>	TMU 1.18	-----	202.35.500	P09-1L	-----	155.40.000	P09-2L	-----	155.41.000	P09-3L	-----	155.42.000	P09-4L	-----	155.43.000	P09-5L	-----	155.44.500	Punta de pluma / Jib end*	-----	155.45.000	TR 12	-----	146.30.000	TN 12	-----	146.31.000	TR 8RM	-----	202.30.000	TR 8M	-----	146.30.800	TR 4	-----	800.32.300	TN 4	-----	146.32.000	<table border="0"> <tr><td>TN2</td><td>-----</td><td>146.32.500</td></tr> <tr><td>BTX 45/BEX 45</td><td>-----</td><td>137.20.500</td></tr> <tr><td>BTX 38R/BEX 38R</td><td>-----</td><td>137.20.000</td></tr> <tr><td>BTX 38/BEX 38</td><td>-----</td><td>149.20.000</td></tr> <tr><td>BEX 45L</td><td>-----</td><td>155.23.500</td></tr> <tr><td>BEX 38RL</td><td>-----</td><td>155.23.800</td></tr> <tr><td>BEX 38L</td><td>-----</td><td>155.23.000</td></tr> <tr><td>ABH 75</td><td>-----</td><td>152.23.000</td></tr> <tr><td>ABH 90</td><td>-----</td><td>146.23.000</td></tr> <tr><td>AR 12</td><td>-----</td><td>137.21.000</td></tr> <tr><td>AN 12</td><td>-----</td><td>146.21.000</td></tr> <tr><td>BE 442</td><td>-----</td><td>146.24.850</td></tr> </table>	TN2	-----	146.32.500	BTX 45/BEX 45	-----	137.20.500	BTX 38R/BEX 38R	-----	137.20.000	BTX 38/BEX 38	-----	149.20.000	BEX 45L	-----	155.23.500	BEX 38RL	-----	155.23.800	BEX 38L	-----	155.23.000	ABH 75	-----	152.23.000	ABH 90	-----	146.23.000	AR 12	-----	137.21.000	AN 12	-----	146.21.000	BE 442	-----	146.24.850
TMU 1.18	-----	202.35.500																																																																											
P09-1L	-----	155.40.000																																																																											
P09-2L	-----	155.41.000																																																																											
P09-3L	-----	155.42.000																																																																											
P09-4L	-----	155.43.000																																																																											
P09-5L	-----	155.44.500																																																																											
Punta de pluma / Jib end*	-----	155.45.000																																																																											
TR 12	-----	146.30.000																																																																											
TN 12	-----	146.31.000																																																																											
TR 8RM	-----	202.30.000																																																																											
TR 8M	-----	146.30.800																																																																											
TR 4	-----	800.32.300																																																																											
TN 4	-----	146.32.000																																																																											
TN2	-----	146.32.500																																																																											
BTX 45/BEX 45	-----	137.20.500																																																																											
BTX 38R/BEX 38R	-----	137.20.000																																																																											
BTX 38/BEX 38	-----	149.20.000																																																																											
BEX 45L	-----	155.23.500																																																																											
BEX 38RL	-----	155.23.800																																																																											
BEX 38L	-----	155.23.000																																																																											
ABH 75	-----	152.23.000																																																																											
ABH 90	-----	146.23.000																																																																											
AR 12	-----	137.21.000																																																																											
AN 12	-----	146.21.000																																																																											
BE 442	-----	146.24.850																																																																											

(H) TRASLACIÓN / TRAVELLING / TRASLATION / ПЕРЕМЕЩЕНИЕ / RAY YÜRÜYÜŞLÜ / متحركة



(H) ESTACIONARIA / STATIONARY / STATIONAIRE / СТАЦИОНАРНОЕ СОСТОЯНИЕ / SABIT / ثابتة



-  TN 2
-  TR 8RM
-  TR 8M
-  TN 4
-  TN 12
-  TR 4
-  TR 12





Fecha / Date: 20/01/2016



Reservado el derecho a modificaciones sin previo aviso. Declinamos toda responsabilidad derivada de la información proporcionada / Subject to modification, without previous warning. This information is supplied without liability / L'entreprise se réserve le droit de procéder à des modifications sans préavis. Nous déclinons toute responsabilité quant aux informations fournies / Мы оставляем за собой право на внесение изменений без предварительного уведомления. Мы снимаем с себя любую ответственность в отношении предоставленной информации / Önceden bildirilmeksizin değiştirilme hakkı saklıdır. Verilen bilgiler için hiçbir sorumluluk kabul etmemekteyiz / حقوق التغيير محفوظة دون إشعار مسبق. دون أدنى مسؤولية عن المعلومات المقدمة











CARGAS / LOADS / CHARGES / НАГРУЗКИ / YÜKLER / الأحمال **J4510**

	SR1 (kg)	Cargas máximas / Maximum loads / Charges maximales / Максимальные нагрузки / Maksimum yük / أقصى حمولة					
		SR1-2000 kg					
	2000 kg @...[m]	Alcance del gancho [m] / Hook reach [m] / Portée du crochet (m) / Радиус действия крюка (m) / Kancanın yüksekliği (m) / مدى الخطاف					
		20	25	30	35	40	45
45 m	25,0	2000	2000	1625	1355	1155	1000
40 m	31,1	2000	2000	2000	1750	1500	—
35 m	35,0	2000	2000	2000	2000	—	—
30 m	30,0	2000	2000	2000	—	—	—
25 m	25,0	2000	2000	—	—	—	—
20 m	20,0	2000	—	—	—	—	—



CARGAS / LOADS / CHARGES / НАГРУЗКИ / YÜKLER / الأحمال **J4510**

	SR2 (kg)	Cargas máximas / Maximum loads / Charges maximales / Максимальные нагрузки / Maksimum yük / أقصى حمولة					
		SR2-2500 kg					
	2500 kg @...[m]	Alcance del gancho [m] / Hook reach [m] / Portée du crochet (m) / Радиус действия крюка (m) / Kancanın yüksekliği (m) / مدى الخطاف					
		20	25	30	35	40	45
45 m	20,5	2500	2000	1625	1355	1155	1000
40 m	25,5	2500	2500	2085	1750	1500	—
35 m	28,6	2500	2500	2375	2000	—	—
30 m	30,0	2500	2500	2500	—	—	—
25 m	25,0	2500	2500	—	—	—	—
20 m	20,0	2500	—	—	—	—	—

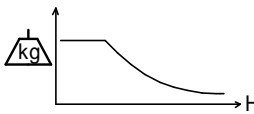
CARACTERISTICAS DE MECANISMOS / MECHANISMS FEATURES / CARACTÉRISTIQUES DES **J4510**

MÉCANISMES / ХАРАКТЕРИСТИКИ МЕХАНИЗМОВ / MEKANİZMALARIN ÖZELLİKLERİ / الخصائص الآلية										
*opcional *optional *en option *опция *opsiyonel *اختياري										
	EC1846 SR2 13,2 kW	EC1856 SR1 13,2 kW	*EC2566VF SR2 18,4 kW	*EC2580VF SR1 18,4 kW	2,8/3,8/4,5m TG825VF 2x3 kW	OG608VF 4 kW	TC360 / *TC360VF 1,9 / *1,8 kW	TH1010 9,2 kW		
	1,3 2,5 2,5 46 23 5	1,1 2 2 56 28 6	1,3 2,5 0..64 0..32	1,1 2 0..82 0..41	0...25 m/min	0... 0,8 r/min sl/min	30/60 m/min *0...30 *30...60 m/min	1 m/min		
	H ≤ SR 193 m		SR 189 m		400V 50Hz		P_{TOTAL}(EC1846/EC1856 + OG608VF + TC360) = 19,1 kW P_{TOTAL}(*EC2566VF/*EC2580VF + OG608VF + *TC360VF) = *24,2 kW			
					480V 60Hz		EC1846 EC1856 TC360 TH1010 kW +20% m/min +20%			

LASTRES INFERIORES / LOWER BALLASTS / LESTS INFÉRIEURS / НИЖНИЙ БАЛЛАСТ / ALT AĞIRLIK TAŞLARI / نقل **J4510**

	H (m)	18	22	30	40	46	49,1
BEX 45 / BTX 45	 4100 kg	6		8	10	12	14
BEX45L		8		10	12	14	14
BEX 38R / BTX 38R		6	8	10	12	16	----
BEX 38 / BTX 38		6	8	10	12	16	----
BEX 38RL		8		10	12	16	----
BEX 38L		8		10	12	16	----
	H (m)	31,9				40,3	
BE 442	 3450 kg	16				20	





H: Altura bajo gancho / Height under hook / Hauteur maximale sous crochet / Высота под крюком / Kanca altı yüksekliği / الارتفاع أسفل الخطاف
 Para alturas intermedias tomar el lastre correspondiente a la altura superior / For intermediate heights take the ballast corresponding to the higher height / Pour les hauteurs intermédiaires, opter pour le lest correspondant à la hauteur immédiatement supérieure / Для промежуточных высот возьмите балласт, соответствующий большей высоте / Orta yükseklikler için daha üst bir yüksekliğe karşılık gelen ağırlığı alınız / لارتفاعات البينية يرجى استخدام النقل العائد للارتفاع الأعلى

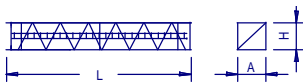
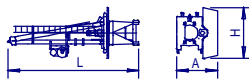
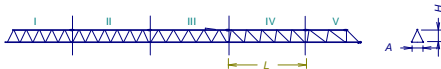
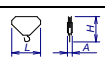

Fecha / Date: 20/01/2016

Reservado el derecho a modificaciones sin previo aviso. Declinamos toda responsabilidad derivada de la información proporcionada / Subject to modification, without previous warning. This information is supplied without liability / L'entreprise se réserve le droit de procéder à des modifications sans préavis. Nous déclinons toute responsabilité quant aux informations fournies / Мы оставляем за собой право на внесение изменений без предварительного уведомления. Мы снимаем с себя любую ответственность в отношении предоставленной информации / Önceden bildirilmezsizin değiştirilme hakkı saklıdır. Verilen bilgiler için hiçbir sorumluluk kabul etmemekteyiz / حقوق التغيير محفوظة دون إشعار مسبق. دون أدنى مسؤولية عن المعلومات المقدمة

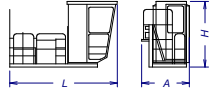
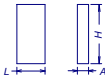
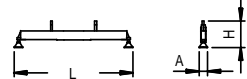

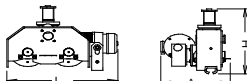
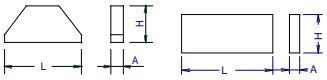
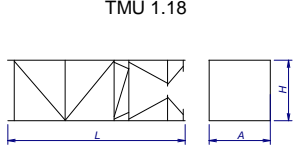
DENOMINACIÓN / DENOMINATION / DÉSIGNATION / НАЗВАНИЕ / AÇIKLAMA / اسم		L [m]	A [m]	H [m]	P / W [kg]
Torre Tower Tour Башня Kule برج	TR 8RM – TR 8M TR 12 – TN 12 TR 4 TN 4 TN 2				8,07 1,19 1,19 2575-2515 12,01 1,19 1,19 2840-2780 3,96 1,18 1,18 1070 4,09 1,19 1,19 1055 2,29 1,19 1,19 785
Conjunto asiento pista, punta de torre, orientación y elevación Slewing table assembly, tower head, slewing and hoisting mechanism Groupe pivot + porte-flèche + mécanisme d'orientation + de levage Сиденье площадки + верхняя секция башни + поворотный механизм + подъемный механизм Göbek +kulenin kafa bölümü+mekanizma+vinç kulesi مجموعة وحدة الدوارن + رأس البرج + آلية الدوران + آلية الرفع					6,97 1,65 2,42 3622
Tramo de pluma Jib section Tronçon de flèche Секция стрелы Вот bölümü أجزاء الذراع	P09 1L (I) P09 2L (II) P09 3L (III) P09 4L (IV) P09 5L (V)				10,13 1 1,15 650 10,13 0,86 1,09 550 10,15 0,86 1,09 565 5,26 0,86 1,09 250 10,12 0,86 1,09 407
Polipasto / Hook assembly / Palan / Полупастм / Kanca takımı / بكرة	SR				0,76 0,16 0,96 135
Carro / Trolley / Chariot / Грузовая тележка / Şaryo / عربة	SR				1,00 1,33 0,73 110
Contrapluma con plataformas / Counterjib with platforms Contre-flèche avec plateformes / Противовесная консоль с платформами / Platformlu kuşruk / المنصة مع المقابل					11,95 1,35 0,4 942
Plataforma y cabina / Platform and cabin / Plateforme et cabine / Платформа и кабина / Platform ve kabin / منصة وكابينة					3,69 1,63 2,25 820
Contrapeso / Counterweight / Contrepoids / Противовес / Denge ağırlığı / موازن معاكسة	Grande / Big / Grand / Большой / Büyük / كبير Pequeño / Small / Petit / Малый / Küçük / صغير				1,08 0,50 2,02 2360 1,08 0,50 1,30 1500
Base grúa Testero largo Crane base Long carriage Base de la grue. Palonnier long Основание крана. Длинная передняя часть Vinç tabanı. Uzun vinç arabası قاعدة الرافعة مقدمة طويلة (للكابينة)	BTX 38 BTX 38R BTX 45				6,11 0,64 1,53 1576 6,11 0,64 1,57 1792 7,01 0,64 1,57 2065
	BTX 38L BTX 38RL BTX 45L				5,46 0,55 0,97 1160 5,46 0,55 0,88 850 4,01 0,55 0,88 660
	BEX 38 BEX 38R BEX 45				5,56 0,3 1,27 1390 5,56 0,3 1,40 1590 6,55 0,3 1,41 1863
Mecanismo traslación grúa / Crane travelling mechanism Mécanisme de translation de la grue / Механизм перемещения крана / Yürüyüş mekanizmalı vinç آلية رفع الرافعة					0,96 0,56 0,66 293
Lastre / Ballast / Lest / Балласт / Alt ağırlık taşları / ثقيل	☑ 2,8m ☑ 3,8m ☑ 4,5m BE 442 BE 434				3,00 0,44 1,30 3700 4,00 0,34 1,30 4100 2,09 0,34 2,10 3450 3,40 0,34 1,69 4300
Torre de montaje / Jacking cage / Tour de montage / Монтажная башня / Kaldırma kafesi / برج التركيب					7,14 1,76 1,71 3200
Torre de montaje sin puerta, carro, plataforma carro y viga de apoyo Jacking cage without door, trolley, trolley platform and beam assembly Tour de montage sans porte, chariot, plateforme de chariot et poutre de soutien Монтажная башня без двери, грузовой тележки, платформы грузовой тележки и опорной балки Kapisız kaldırma kafesi, vinç köprüsü arabası, vinç köprüsü arabası platformu ve giriş takımı برج التركيب بدون بوابة ، وعربة ومنصة متحركة وعارضة تدعيم			TMU 1.18		7,14 1,76 1,71 2450

T	H	Component		H	T
1	4,5	TN 4	146.32.000	TN 4	4,5 1
2	8,5	TN 4		TN 4	8,5 2
3	20,3	TN 12	146.31.000	TN 12	20,3 3
4	32,2	TR 12	146.30.000	TR 12	32,2 4
5	40,1	TR 8M	146.30.800	TR 8M	40,1 5
6	43,9	T 3-90	133.32.000	T 3-90	43,9 6
7	46,8				46,8 7
8	49,8				49,8 8
9	52,7				52,7 9
		AN 90	133.21.000		
		AND 90	133.21.800		
		AN 150	161.21.000		
		AND 150	161.21.050		
		AL 20	153.21.800		
		ALD 20	160.21.250		
		AS 20	160.21.010		
		ASD 20/24	160.21.080		
		ASR 20	160.21.200		
		ASRD 20/24	156.21.000		

AN 90 133.21.000
AND 90 133.21.800
AN 150 161.21.000
AND 150 161.21.050
AL 20 153.21.800
ALD 20 160.21.250
AS 20 160.21.010
ASD 20/24 160.21.080
ASR 20 160.21.200
ASRD 20/24 156.21.000

T: Torre / Tower / Tour / Башни / Kuleler / أبراج
H: Altura / Height / Hauteur / Высота / Yükseklik / ارتفاع

Otras configuraciones de torre / Other tower configuration / Autres configurations / Прочие конфигурации / Diğer konfigürasyonlar / مكونات أخرى

Transporte
Transport / Transport /
Транспортировка / Taşıma /
نقل

H=38,4 + AN12

2x

3x HIGH CUBE 40'

≤ 6xTN4

TREPADO / CLIMBING / TÉLESCOPAGE / ЛЕСТНИЦА / TIRMANMA / التسلق J4510

$h_{max}: 3 \times TR4 + 6 \times TN4$

h (m)	36
D (m)	6 - 10
P (KN)	319 294
Rmax (KN)	129 244

TR4: 800.32.300

Trepado interno / Internal climbing. / Téléscopage intérieur / Внутренняя лестница / Bina içi tırmanma / التسلق الداخلي

- ⚠ Viento fuera de servicio / Out of service wind / Vitesse du vent hors service / Ветровая нагрузка в покое / Rüzgar devre dışı / الريح خارج الخدمة
- 📄 Consultar / Consult / Nous consulter / Консультируйтесь / Danışınız / الرجوع إلى
- ▶ En servicio / In service / En service / В работе / Devrede / في الخدمة
- Fuera de servicio / Out of service / Hors service / В покое / Devre dışı / خارج الخدمة



Ctra./Rd. Madrid - Irún Km. 415 - 20.213 IDIAZABAL [Gipuzkoa] ESPAÑA / SPAIN
P.O. Box, 23 - 20.200 BEASAIN - E-mail: jaso@jaso.com
Tel. +34 943 - 18 70 00 • Fax. +34 943 - 18 70 20
www.jaso.com

Fecha / Date: 20/01/2016

Reservado el derecho a modificaciones sin previo aviso. Declinamos toda responsabilidad derivada de la información proporcionada / Subject to modification, without previous warning. This information is supplied without liability / L'entreprise se réserve le droit de procéder à des modifications sans préavis. Nous déclinons toute responsabilité quant aux informations fournies / Мы оставляем за собой право на внесение изменений без предварительного уведомления. Мы снимаем с себя любую ответственность в отношении предоставленной информации / Önceden bildirilmeksizin değiştirilme hakkı saklıdır. Verilen bilgiler için hiçbir sorumluluk kabul etmemekteyiz /

حقوق التغيير محفوظة دون إشعار مسبق. دون أدنى مسؤولية عن المعلومات المقدمة



DELEGACION / DEALER