

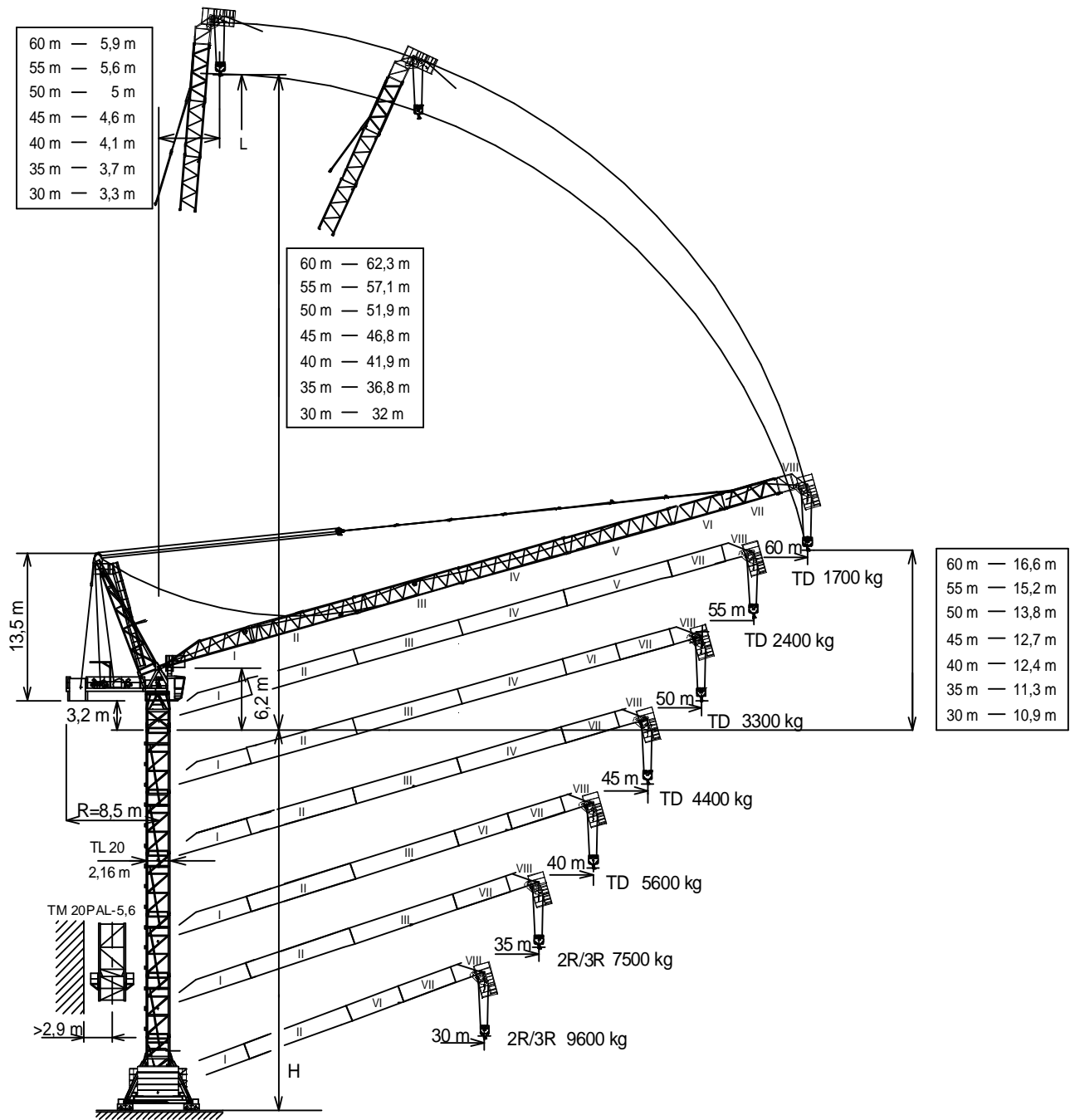

UNE 58-101
FEM 1001

UNE-EN-ISO 9001



Máxima altura de torre sin arriostrar (m). Maximum tower height without fastening (m). Hauteur maximale de tour sans ancrage (m). Максимальная высота башни без крепления (м). Desteksiz maksimum kule yüksekliği (m). أقصى ارتفاع للبرج بدون ربط (م)	H		
* Tramo pluma / Jib section / Tronçon de flèche / Секция стрелы / Bom bölümü / أجزاء الذراع			
** Punta de pluma / Jib end / Pointe de flèche / Конец стрелы / Bom ucu / مقدمة الذراع			
*Tramo pluma I / Jib section I	207.40.000	AL 20	153.21.800
*Tramo pluma II / Jib section II	207.41.000	AS 20	160.21.010
*Tramo pluma III / Jib section III	207.42.000	ASR 20	160.21.200
*Tramo pluma IV / Jib section IV	207.43.000	TL 20	153.31.000
*Tramo pluma V / Jib section V	207.44.500	TL 20-5,6	204.31.400
*Tramo pluma VI / Jib section VI	207.44.000	TS 20-5,6	204.31.200
*Tramo pluma VII / Jib section VII	207.45.000	TS 20-5,6A	204.31.500
**Punta pluma VIII/ Jib end VIII	207.46.000	TSR 20-5,6	204.31.000
BLI 6-20-5,6	211.20.500	TSR 20-5,6A	204.31.300
BSI 8-20-5,6	211.20.000	TM 20PAL-5,6	166.35.500
ABH 100	201.23.000		



Fecha / Date: 20/01/2016

Reservado el derecho a modificaciones sin previo aviso. Declinamos toda responsabilidad derivada de la información proporcionada / Subject to modification, without previous warning. This information is supplied without liability / L'entreprise se réserve le droit de procéder à des modifications sans préavis. Nous déclinons toute responsabilité quant aux informations fournies / Мы оставляем за собой право на внесение изменений без предварительного уведомления. Мы снимаем с себя любую ответственность в отношении предоставленной информации / Önceden bildirilmeksizin değiştirilme hakkı saklıdır. Verilen bilgiler için hiçbir sorumluluk kabul etmemekteyiz / حقوق التغيير محفوظة دون إشعار مسبق. دون أدنى مسؤولية عن المعلومات المقدمة



(H) TRASLACIÓN / TRAVELLING /

TRASLATION / ПЕРЕМЕЩЕНИЕ / RAY YÜRÜYÜŞLÜ / متحركة

(H) ESTACIONARIA / STATIONARY /

STATIONAIRE / СТАЦИОНАРНОЕ СОСТОЯНИЕ / SABIT / ثابتة

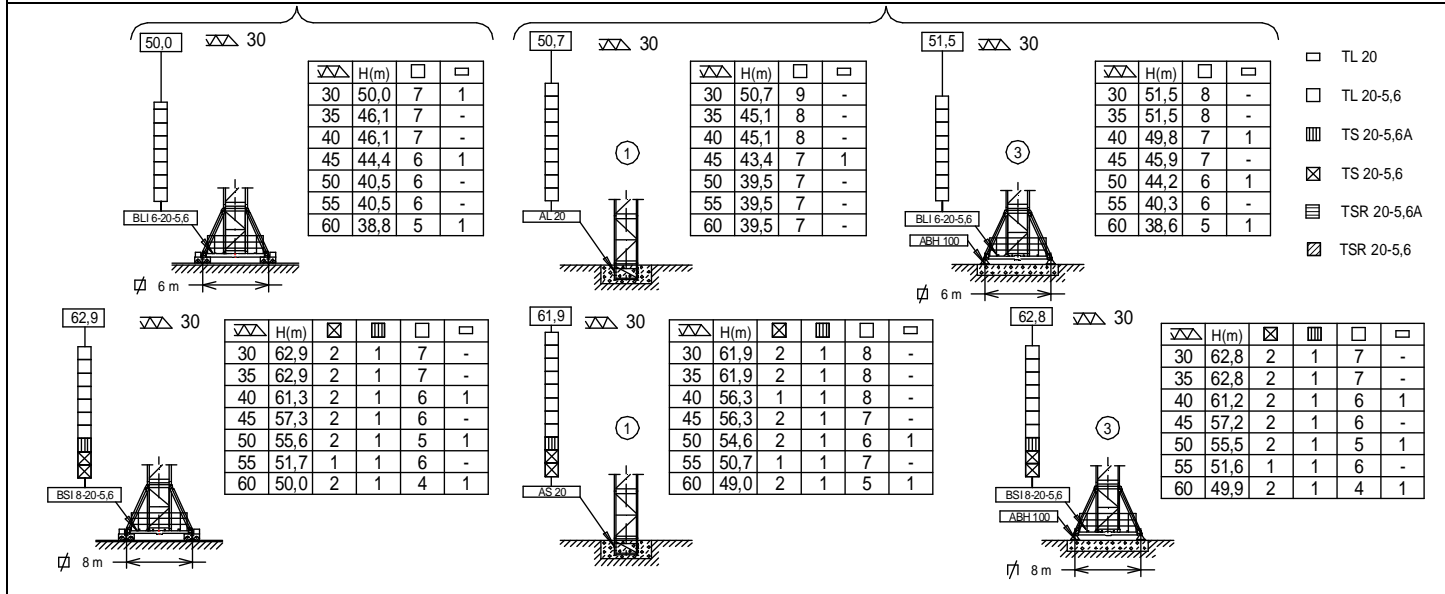

TREPADO / CLIMBING / TÉLESCOPAGE / ЛЕСТНИЦА / TIRMANMA / التسلق

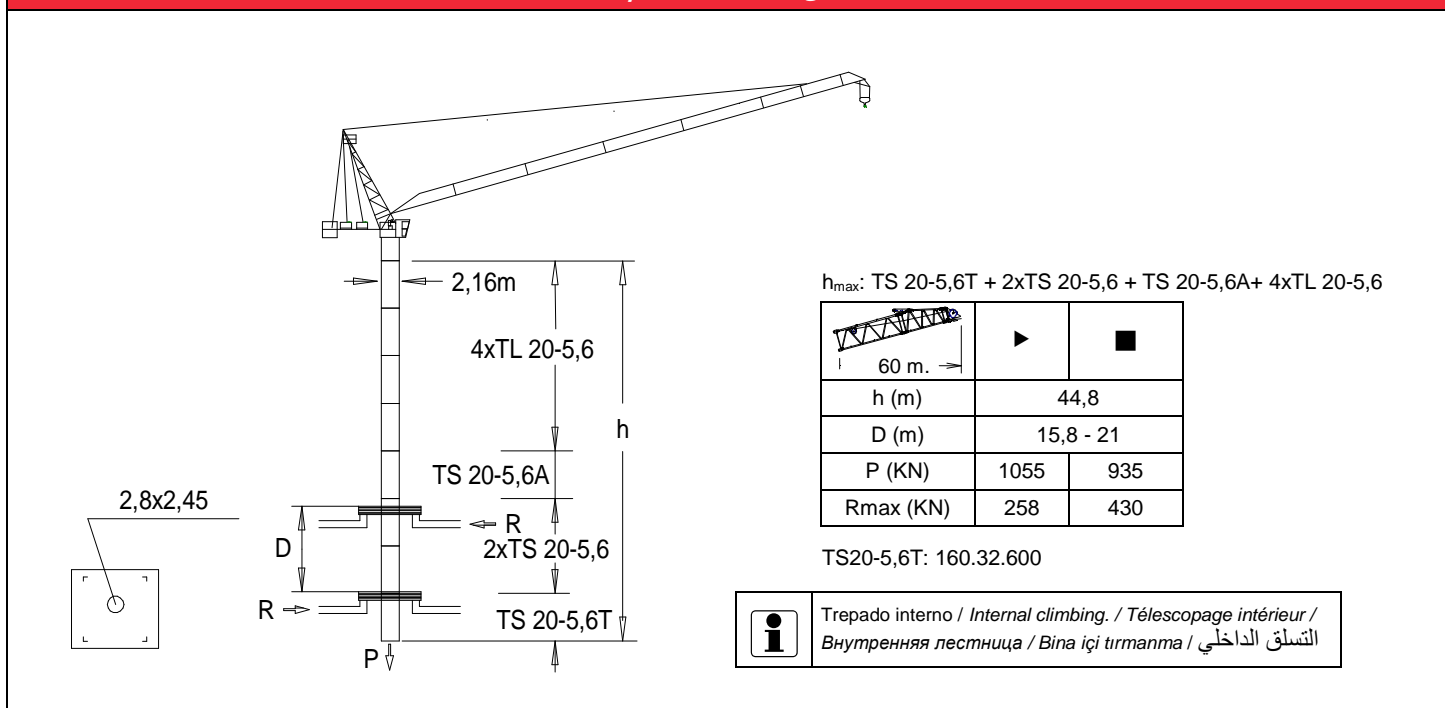



- 🚫 Viento fuera de servicio / Out of service wind / Vitesse du vent hors service / Ветровая нагрузка в покое / Rüzgar devre dışı / الريح خارج الخدمة
- 📄 Consultar / Consult / Nous consulter / Консультируйтесь / Danışınız / الرجوع إلى
- ▶ En servicio / In service / En service / В работе / Devrede / في الخدمة
- Fuera de servicio / Out of service / Hors service / В покое / Devre dışı / خارج الخدمة



Fecha / Date: 20/01/2016





FEM 1001

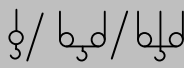



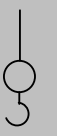
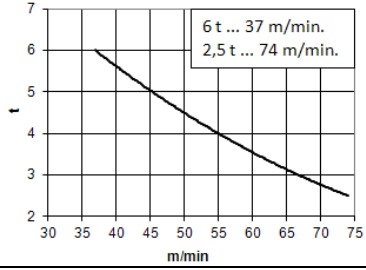
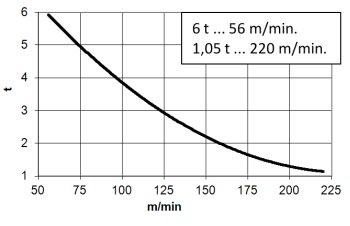

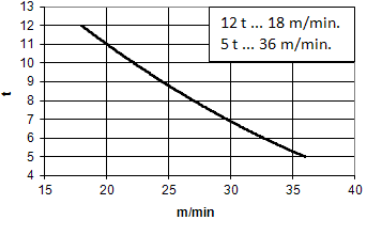
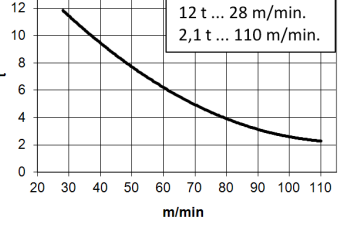
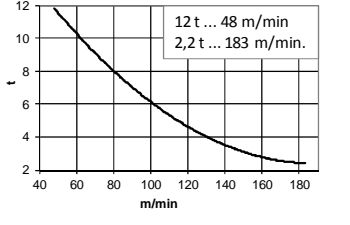

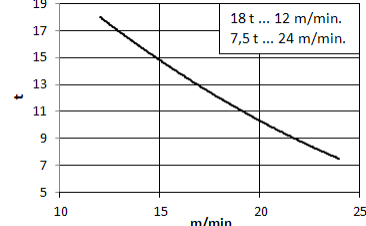
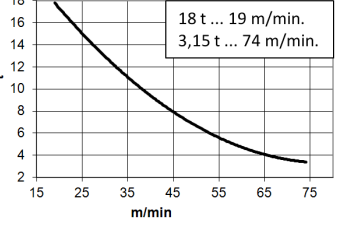
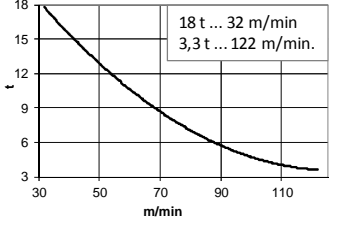
Reservado el derecho a modificaciones sin previo aviso. Declinamos toda responsabilidad derivada de la información proporcionada / Subject to modification, without previous warning. This information is supplied without liability / L'entreprise se réserve le droit de procéder à des modifications sans préavis. Nous déclinons toute responsabilité quant aux informations fournies / Мы оставляем за собой право на внесение изменений без предварительного уведомления. Мы снимаем с себя любую ответственность в отношении предоставленной информации / Önceden bildirilmeksizin değiştirilme hakkı saklıdır. Verilen bilgiler için hiçbir sorumluluk kabul etmemekteyiz / حقوق التغيير محفوظة دون إشعار مسبق. دون أدنى مسؤولية عن المعلومات المقدمة

 TD [t]		Cargas máximas / Maximum loads / Charges maximales / Максимальные нагрузки / Maksimum yük / أقصى حمولة TD – 6t							
 [m]	TD 6t @ (m)	Alcance del gancho [m] / Hook reach [m] / Portée du crochet (m) / Радиус действия крюка (m) / Kancanın yüksekliği (m) / مدى الخطاف							
		25	30	35	40	45	50	55	60
60 m	37,7	6	6	6	5,4	4,2	3,2	2,4	1,7
55 m	37,8	6	6	6	5,4	4,2	3,2	2,4	—
50 m	38,1	6	6	6	5,5	4,3	3,3	—	—
45 m	38,5	6	6	6	5,6	4,4	—	—	—
40 m	38,5	6	6	6	5,6	—	—	—	—
35 m	35	6	6	6	—	—	—	—	—
30 m	30,0	6	6	—	—	—	—	—	—

 TD/2R/3R [t]			Cargas máximas / Maximum loads / Charges maximales / Максимальные нагрузки / Maksimum yük / أقصى حمولة TD/2R/3R - 6t/12t/18t									
 [m]	3R 18t @...[m]	2R 12t @...[m]	TD 6t @...[m]	Alcance del gancho [m] / Hook reach [m] / Portée du crochet (m) / Радиус действия крюка (m) / Kancanın yüksekliği (m) / مدى الخطاف								
				20	25	30	35	40	45	50	55	60
60 m	18t @...[m]	24,2	37,1	12,0	11,4	8,6	6,6	5,2	3,9	3,0	2,2	1,5
55 m				12,0	11,4	8,6	6,6	5,2	3,9	3,0	2,2	—
50 m	17,9	24,3	37,4	15,6	11,5	8,7	6,7	5,3	4,1	3,1	—	—
45 m	17,9	24,3	37,8	15,6	11,5	8,8	6,8	5,4	4,2	—	—	—
40 m	17,9	24,3	37,8	15,6	11,5	8,8	6,8	5,4	—	—	—	—
35 m	18,5	25,4	35,0	16,4	12,2	9,5	7,5	—	—	—	—	—
30 m	18,5	25,5	30,0	16,4	12,3	9,6	—	—	—	—	—	—

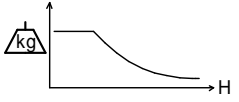
*opcional *optional *en option *опция *opsiyonel *اختياري			
	EC6074VF 44,1 kW	EC88110VF 65 kW	*EC150185VF 110 kW
			
			
			

				 400V 50Hz	
TG2020VF 2x7,3 kW	OG1507V 2x5,5 kW	EP6015VF 44,1 kW	TH2006 15 kW	P_{TOTAL}(EC88110VF + OG1507VF + EP6015VF) = 120,1 kW P_{TOTAL}(EC150185VF + OG1507VF + EP6015VF) = 165,1 kW	
0...20 m/min	0...0,8 r/min sl/min	1,5 min	0,6 m/min	 H ≤ TD 568m 2R 284m 3R 189m	

Fecha / Date: 20/01/2016

 FEM 1001



Reservado el derecho a modificaciones sin previo aviso. Declinamos toda responsabilidad derivada de la información proporcionada / Subject to modification, without previous warning. This information is supplied without liability / L'entreprise se réserve le droit de procéder à des modifications sans préavis. Nous déclinons toute responsabilité quant aux informations fournies / Мы оставляем за собой право на внесение изменений без предварительного уведомления. Мы снимаем с себя любую ответственность в отношении предоставленной информации / Önceden bildirilmeksizin değiştirilme hakkı saklıdır. Verilen bilgiler için hiçbir sorumluluk kabul etmemekteyiz / حقوق التغيير محفوظة دون إشعار مسبق. دون أدنى مسؤولية عن المعلومات المقدمة

DENOMINACIÓN / DENOMINATION / DÉSIGNATION / НАЗВАНИЕ / AÇIKLAMA / اسم		L [m]	A [m]	H [m]	P / W [kg]		
Torre inferior / Lower tower / Tour inférieure / Нижняя башня Alt kule / البرج السفلي		TLI20-5,6 TSI20-5,6 TSRI20-5,6		5,886 5,966 5,990	2,306 2,328 2,257	2,357 2,390 2,257	4235 5390 6562
Torre / Tower / Tour Башня / Kule / برج		TL20 TL20-5,6 TS20-5,6 TSR20-5,6 TSR20-5,6A TS20-5,6A		4,175 5,886 5,966 5,990 5,926 5,978	2,201 2,306 2,328 2,257 2,388 2,381	2,281 2,357 2,390 2,257 2,325 2,331	2095 2938 3604 4262 3637 4221
Torre asiento pista, base punta torre y orientación Slewing table, tower head base and slewing mechanism Tour pivot + base du porte-flèche + mécanisme d'orientation Сиденье площадки + основание верхней секции башни + поворотный механизм Döner tabla+kule kafa bölümü tabanı+mekanizma برج وحدة الدوران + قاعدة رأس البرج + آلية الدوران				6,970	2,550	3,057	9500
Estructura punta de torre sin base Tower head structure without base Structure de porte-flèche sans base Структура верхней секции башни без основания Tabansız kule başının yapısı هيكل رأس البرج بدون قاعدة				11,58	1,910	2,033	5470
Tramo de pluma Jib section Tronçon de flèche Секция стрелы Vom bölümü أجزاء الذراع		(I) (II) (III) (IV) (V) (VI) (VII)		9,180 10,160 10,160 10,160 10,160 5,270 5,270	2,040 1,266 1,266 1,266 1,266 1,266 1,266	1,765 1,565 1,565 1,565 1,565 1,565 1,610	1585 1410 1340 1190 1000 580 770
Punta de pluma / Jib end / Pointe de flèche / Конец стрелы / Vom ucu / مقدمة الذراع				3,420	1,560	3,585	856
Polipasto / Hook assembly / Palan / Полуспаст / Kanca takımı / بكرة				0,910	0,350	1,370	455
Tirante sostén pluma / Jib support tie / Tirant de fleche / Растяжка поддержки стрелы / Kol destek bağları / مشد دعامة الذراع				5,000	0,360	0,450	1232
Estructura contrapluma / Counterjib structure / Structure de contre- flèche / Структура противовесной консоли / Denge kolunun yapısı هيكل الذراع المعاكس				7,110	1,875	0,540	1145
Contrapluma con mecanismos / Counterjib with mechanisms / Contre-flèche avec mécanismes / Противовесная консоль с механизмами / Mekanizmalı denge kolu الذراع المعاكس مع الآليات				7,110	2,230	1,819	9200
Plataforma y cabina / Platform and cabin / Plateforme et cabine / Платформа и кабина / Platform ve kabin / منصة وكابينة				3,420	2,060	2,400	1095
Mecanismos Mechanisms Mécanismes de Механизмы Mekanizmalar آليات كهربائية		Elevación carga / Hoisting / levage de charge / Подъем груза / Yük kaldırma / رافع الحمولة Elevación pluma / Luffing / Relevage de flèche / Подъем стрелы / Yük kaldırma ve indirme / رافع الذراع		1,919	2,110	1,540	3830
Transporte torre de montaje / Jacking cage transport / Transport de tour de montage / Транспортировка монтажной башни / Kaldırma kafesinin taşınması / نقل برج التركيب		TM 20PAL-5,6		9,550	2,070	2,520	5,690

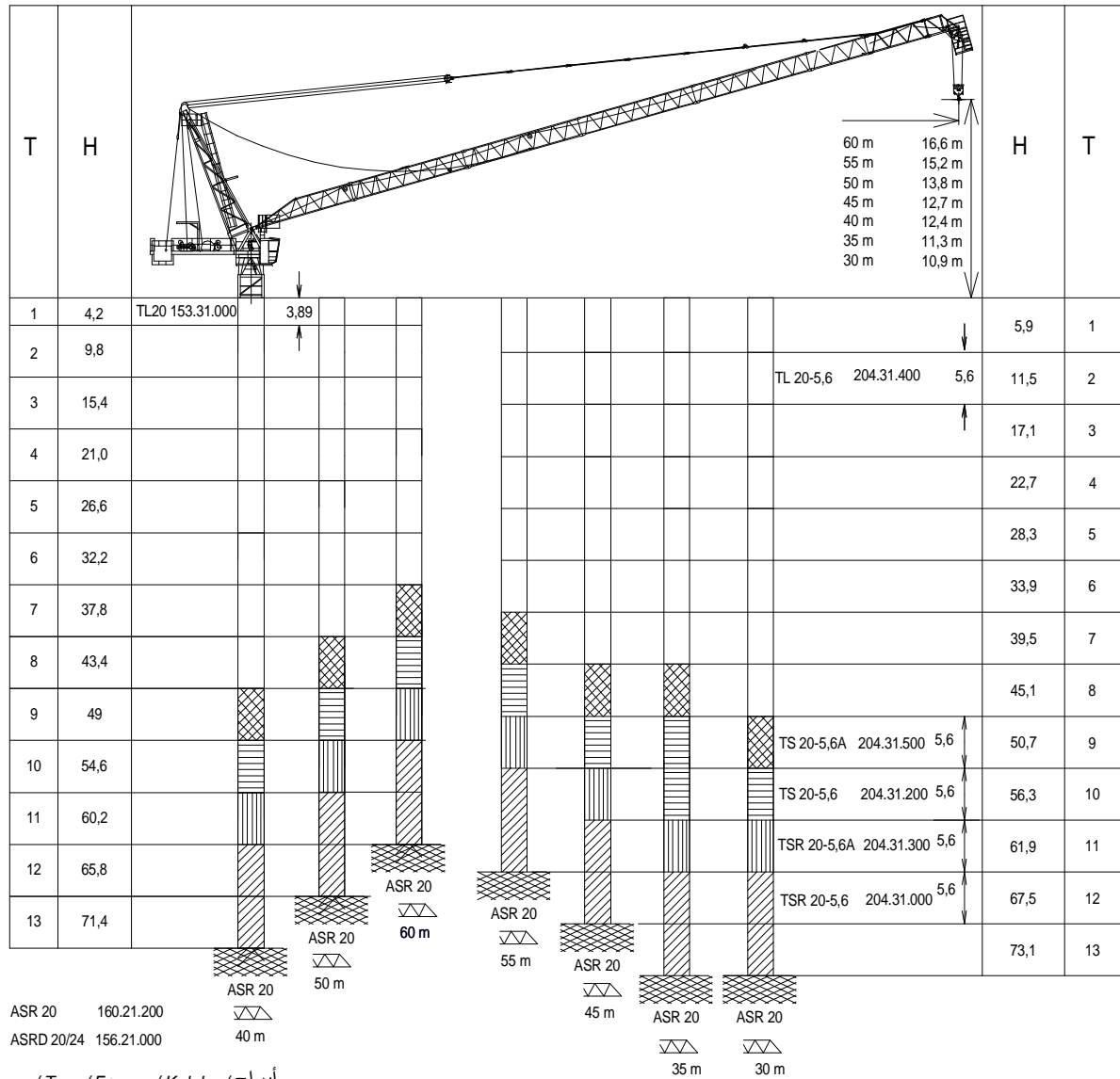

T: Torre / Tower / Tour / Башни / Kuleler / أبراج
H: Altura / Height / Hauteur / Высота / Yükseklik / ارتفاع



Otras configuraciones de torre / Other tower configuration / Autres configurations / Прочие конфигурации / Diğer konfigürasyonlar / مكونات أخرى

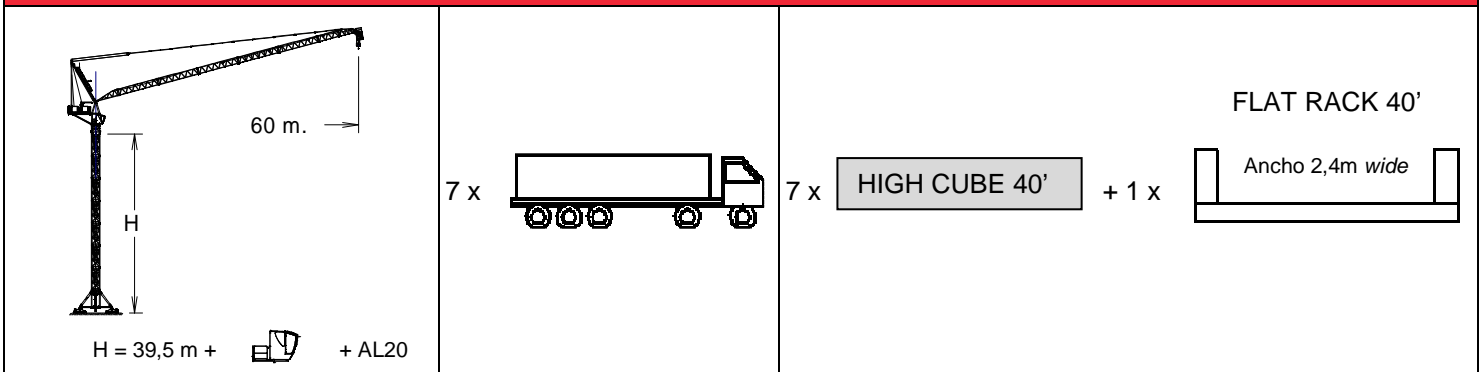

Ctra./Rd. Madrid - Irún Km. 415 - 20.213 IDIAZABAL [Gipuzkoa] ESPAÑA / SPAIN
P.O. Box, 23 - 20.200 BEASAIN - E-mail: jaso@jaso.com
Tel. +34 943 - 18 70 00 • Fax. +34 943 - 18 70 20
www.jaso.com

Fecha / Date: 20/01/2016

FEM 1001

DELEGACION / DEALER

Reservado el derecho a modificaciones sin previo aviso. Declinamos toda responsabilidad derivada de la información proporcionada / Subject to modification, without previous warning. This information is supplied without liability / L'entreprise se réserve le droit de procéder à des modifications sans préavis. Nous déclinons toute responsabilité quant aux informations fournies / Мы оставляем за собой право на внесение изменений без предварительного уведомления. Мы снимаем с себя любую ответственность в отношении предоставленной информации / Önceden bildirilmeksizin değiştirilme hakkı saklıdır. Verilen bilgiler için hiçbir sorumluluk kabul etmemekteyiz /

حقوق التغيير محفوظة دون إشعار مسبق. دون أدنى مسؤولية عن المعلومات المقدمة