



(H) TRASLACIÓN / TRAVELLING /

TRASLACION / ПЕРЕМЕЩЕНИЕ / RAY YÜRÜYÜŞLÜ / متحركة

(H) ESTACIONARIA / STATIONARY /

STATIONAIRE / СТАЦИОНАРНОЕ СОСТОЯНИЕ / SABIT / ثابتة

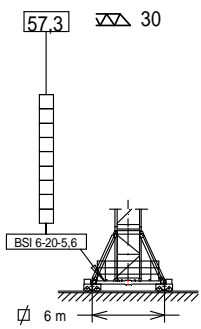

▽	H(m)	□	▣
30	57,3	9	-
35	51,7	8	-
40	51,7	8	-
45	46,1	7	-
50	46,1	7	-
55	44,4	6	1
60	40,5	6	-

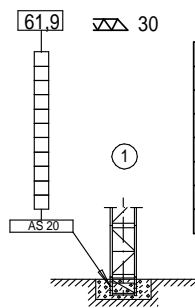

▽	H(m)	□	▣
30	61,9	11	-
35	60,2	10	1
40	56,3	10	-
45	56,3	10	-
50	54,6	9	1
55	50,7	9	-
60	49,0	8	1

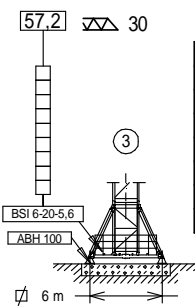

▽	H(m)	□	▣
30	57,2	9	-
35	51,6	8	-
40	51,6	8	-
45	46,0	7	-
50	46,0	7	-
55	44,2	6	1
60	40,4	6	-

- ▣ TS 20
- TS 20-5,6
- ▣ TSR 20-5,6A
- ▣ TSR 20-5,6

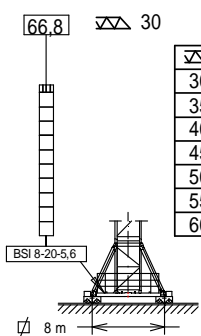

▽	H(m)	□	▣
30	66,8	10	1
35	63,0	10	-
40	61,2	9	1
45	57,4	9	-
50	57,4	9	-
55	55,6	8	1
60	51,7	8	-

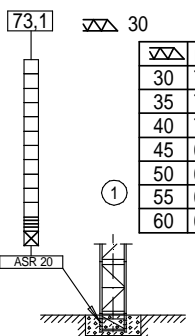

▽	H(m)	▣	▣	□	▣
30	73,1	1	1	11	-
35	73,1	2	1	10	-
40	71,4	2	1	9	1
45	67,5	2	1	9	-
50	65,8	2	1	8	1
55	61,9	1	1	9	-
60	61,9	2	1	8	-

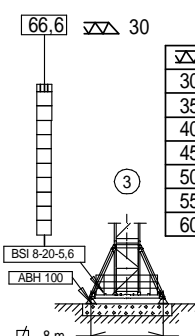

▽	H(m)	□	▣
30	66,6	10	1
35	62,8	10	-
40	61,0	9	1
45	57,2	9	-
50	57,2	9	-
55	55,4	8	1
60	51,6	8	-

TREPADO / CLIMBING / TÉLESCOPAGE / ЛЕСТНИЦА / TIRMANMA / التسلق

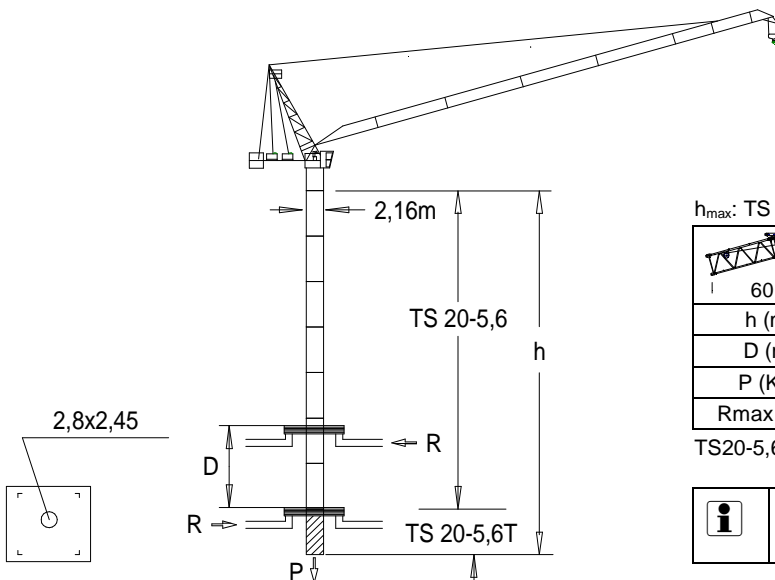

h<sub>max</sub>: TS 20-5,6T + 5xTS 20-5,6

	▶	■
h (m)	33,9	
D (m)	15,2 - 17	
P (KN)	1062	942
R <sub>max</sub> (KN)	253	304

TS20-5,6T: 160.32.600



**i** Trepado interno / Internal climbing. / Téléscopage intérieur / Внутренняя лестница / Bina içi tirmanma / التسلق الداخلي

**⚠** Viento fuera de servicio / Out of service wind / Vitesse du vent hors service / Ветровая нагрузка в покое / Rüzgar devre dışı / الريح خارج الخدمة

**i** Consultar / Consult / Nous consulter / Консультируйтесь / Danışınız / الرجوع إلى







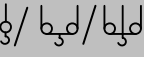





▶ En servicio / In service / En service / В работе / Devrede / في الخدمة

■ Fuera de servicio / Out of service / Hors service / В покое / Devre dışı / خارج الخدمة

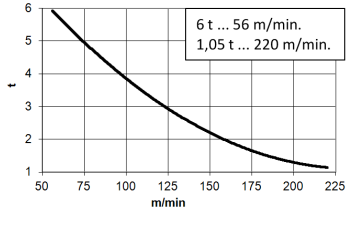
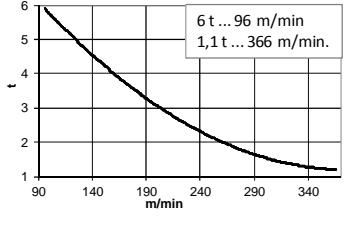
 TD [t]	TD 6t @ (m)	Cargas máximas / Maximum loads / Charges maximales / Максимальные нагрузки / Maksimum yük / أقصى حمولة TD – 6t							
		Alcance del gancho [m] / Hook reach [m] / Portée du crochet (m) / Радиус действия крюка (m) / Kancanın yüksekliği (m) / مدى الخطاف							
		25	30	35	40	45	50	55	60
60 m	41,5	6,0	6,0	6,0	6,0	5,1	3,9	3,0	2,2
55 m	42,6	6,0	6,0	6,0	6,0	5,4	4,3	3,3	—
50 m	43,2	6,0	6,0	6,0	6,0	5,5	4,4	—	—
45 m	43,8	6,0	6,0	6,0	6,0	5,7	—	—	—
40 m	40,0	6,0	6,0	6,0	6,0	—	—	—	—
35 m	35,0	6,0	6,0	6,0	—	—	—	—	—
30 m	30,0	6,0	6,0	—	—	—	—	—	—

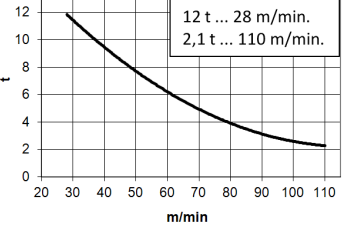
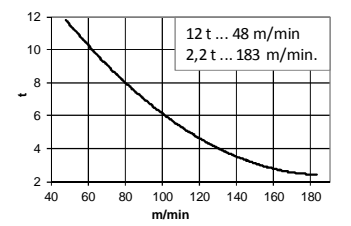
 TD/2R/3R [t]	3R 18t @...[m]	2R 12t @...[m]	TD 6t @...[m]	Cargas máximas / Maximum loads / Charges maximales / Максимальные нагрузки / Maksimum yük / أقصى حمولة TD/2R/3R - 6t/12t/18t								
				Alcance del gancho [m] / Hook reach [m] / Portée du crochet (m) / Радиус действия крюка (m) / Kancanın yüksekliği (m) / مدى الخطاف								
				20	25	30	35	40	45	50	55	60
60 m		27,5	41,0	12,0	12,0	10,5	8,1	6,3	4,9	3,8	2,8	2,0
55 m		27,9	42,0	12,0	12,0	10,7	8,4	6,6	5,2	4,1	3,1	—
50 m	20,9	28,1	42,6	18,0	14,2	10,9	8,5	6,8	5,4	4,2	—	—
45 m	20,9	28,2	43,1	18,0	14,2	11,0	8,7	6,9	5,5	—	—	—
40 m	21,1	28,6	40,0	18,0	14,4	11,2	8,9	7,1	—	—	—	—
35 m	21,1	28,8	35,0	18,0	14,5	11,3	9,0	—	—	—	—	—
30 m	21,3	29,1	30,0	18,0	14,7	11,5	—	—	—	—	—	—

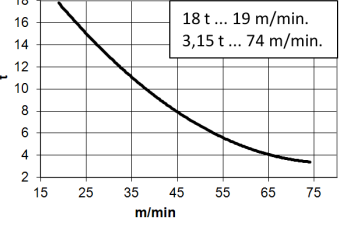
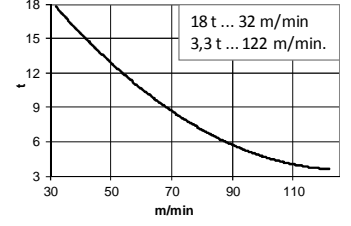
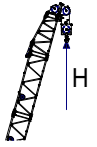
**CARACTERISTICAS DE MECANISMOS / MECHANISMS FEATURES / CARACTÉRISTIQUES DES MÉCANISMES / ХАРАКТЕРИСТИКИ МЕХАНИЗМОВ / MEKANİZMALARIN ÖZELLİKLERİ / الخصائص الآلية** **J265PA**

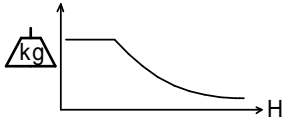
<p>*opcional *optional *en option *опция *opsiyonel *اختياري</p>															
	<p><b>EC88110VF</b> <b>65 kW</b></p>	<p><b>*EC150185VF</b> <b>110 kW</b></p>	<p><b>TG2020VF</b> <b>2x7,3 kW</b></p>	<p><b>OG1507VF</b> <b>2x5,5 kW</b></p>	<p><b>EP6015VF</b> <b>44,1 kW</b></p>	<p><b>TH2006</b> <b>15 kW</b></p>									
			<p>0...20 m/min</p>	<p>0...0,8 r/min sl/min</p>	<p>1,5 min</p>	<p>0,6 m/min</p>									
			 <b>400V 50Hz</b>  <b>P<sub>TOTAL</sub>(EC88110VF + OG1507VF + EP6015VF) = 120,1 kW</b> <b>P<sub>TOTAL</sub>(EC150185VF + OG1507VF + EP6015VF) = 165,1 kW</b>												
			 <table border="0" style="margin-left: 20px;"> <tr> <td>H ≤</td> <td>TD</td> <td>630m</td> </tr> <tr> <td></td> <td>2R</td> <td>315m</td> </tr> <tr> <td></td> <td>3R</td> <td>210m</td> </tr> </table> <div style="display: flex; align-items: center; margin-top: 10px;">   </div>				H ≤	TD	630m		2R	315m		3R	210m
H ≤	TD	630m													
	2R	315m													
	3R	210m													



Fecha / Date: **04/07/2016**

 **FEM 1001**

Reservado el derecho a modificaciones sin previo aviso. Declinamos toda responsabilidad derivada de la información proporcionada / Subject to modification, without previous warning. This information is supplied without liability / L'entreprise se réserve le droit de procéder à des modifications sans préavis. Nous déclinons toute responsabilité quant aux informations fournies / Мы оставляем за собой право на внесение изменений без предварительного уведомления. Мы снимаем с себя любую ответственность в отношении предоставленной информации / Önceden bildirilmeksizin değiştirilme hakkı saklıdır. Verilen bilgiler için hiçbir sorumluluk kabul etmemekteyiz / حقوق التغيير محفوظة دون إشعار مسبق. دون أدنى مسؤولية عن المعلومات المقدمة

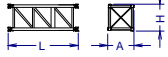
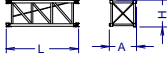
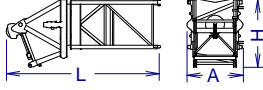
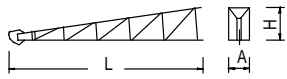
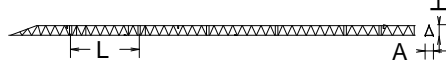
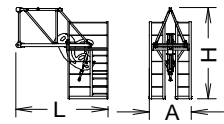
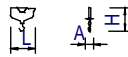
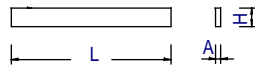
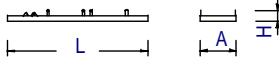
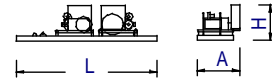
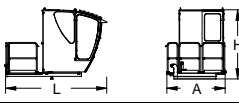
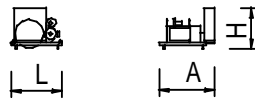
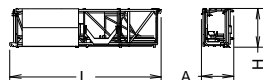
DENOMINACIÓN / DENOMINATION / DÉSIGNATION / НАЗВАНИЕ / AÇIKLAMA / اسم		L [m]	A [m]	H [m]	P / W [kg]	
Torre inferior / Lower tower Tour inférieure / Нижняя башня Alt kule / البرج السفلي	TSI20-5,6		5,966	2,328	2,390	5390
Torre / Tower Tour Башня / Kule / برج	TS20 TS20-5,6 TSR20-5,6A TSR20-5,6 TR24-5,6		4,236 5,966 5,926 5,990 5,990	2,335 2,328 2,388 2,257 2,760	2,348 2,390 2,325 2,257 2,835	2686 3604 3637 4262 4,625
Torre asiento pista, base punta torre y orientación Slewing table, tower head base and slewing mechanism Tour pivot + base du porte-flèche + mécanisme d'orientation Сиденье площадки + основание верхней секции башни + поворотный механизм Döner tabla+kule kafa bölümü tabanı+mekanizma برج وحدة الدوارن + قاعدة رأس البرج + آلية الدوران			5,918	2,675	3,085	10200
Punta de torre + pasteca Tower head +reeving block Structure de porte-flèche + moufle et fléchette			11,663	1,910	2,033	6000
Tramo de pluma Jib section Tronçon de flèche Секция стрелы Вом bölümü أجزاء الذراع	(I) (II) (III) (IV) (V) (VI) (VII)		9,250 10,200 10,200 10,200 10,200 5,310 5,293	2,090 1,266 1,266 1,266 1,266 1,266 1,266	1,770 1,604 1,597 1,577 1,577 1,577 1,630	1580 1490 1373 1225 1171 682 926
Punta de pluma / Jib end Pointe de flèche / Конец стрелы / Вом ucu / مقدمة الذراع			3,420	1,580	3,585	880
Polipasto / Hook assembly Palan / Полиспаст / Kancа takımı / بكرة			0,918	0,394	1,218	440
Tirante sostén pluma / Jib support tie / Tirant de fleche / Растяжка поддержки стрелы / Kol destek bağları مشد دعامة الذراع			5,842	0,360	0,370	1115
Estructura contrapluma / Counterjib structure Structure de contre-flèche / Структура противовесной консоли / Denge kolunun yapısı هيكل الذراع المعاكس			7,765	1,925	0,725	1437
Contrapluma con mecanismos / Counterjib with mechanisms / Contre-flèche avec mécanismes / Противовесная консоль с механизмами / Mekanizmalı denge kolu الذراع المعاكس مع الآليات			7,765	2,230	2,390	11800
Plataforma y cabina / Platform and cabin / Plateforme et cabine / Платформа и кабина / Platform ve kabin / منصة وكابينة			3,420	2,060	2,400	1095
Mecanismos Mechanisms Mécanismes de Механизмы Mekanizmalar اليات كهربائية	Elevación carga / Hoisting / levage de charge / Подъем груза / Yük kaldırma/ رافع الحمولة Elevación pluma / Luffing / Relevage de flèche / Подъем стрелы / Yük kaldırma ve indirme / رافع الذراع		2,372 1,967	2,062 2,631	2,077 1,895	6200 3200
Transporte torre de montaje/ Jacking cage transport / Transport de tour de montage / Транспортировка монтажной башни / Kaldırma kafesinin taşınması / نقل برج التركيب	TM 20PAL-5,6		9,550	2,070	2,520	5,690

Fecha / Date: 04/07/2016

 **FEM 1001**



Reservado el derecho a modificaciones sin previo aviso. Declinamos toda responsabilidad derivada de la información proporcionada / Subject to modification, without previous warning. This information is supplied without liability / L'entreprise se réserve le droit de procéder à des modifications sans préavis. Nous déclinons toute responsabilité quant aux informations fournies / Мы оставляем за собой право на внесение изменений без предварительного уведомления. Мы снимаем с себя любую ответственность в отношении предоставленной информации / Önceden bildirilmeksizin değiştirilme hakkı saklıdır. Verilen bilgiler için hiçbir sorumluluk kabul etmemekteyiz / حقوق التغيير محفوظة دون إشعار مسبق. دون أدنى مسؤولية عن المعلومات المقدمة

